



NH40SZ Automatic Changeover Switch

1. General

NH40SZ automatic changeover switch disconnecter integrates electrical and mechanical interlocking systems to guarantee safe transfer operation. It is applicable for the three-phase four-wire power supply system of AC 50Hz, rated voltage AC 380V and below, DC 440V and below, rated current up to 3200A. It can realize automatic and manual changeover between normal and back up power supply power, and stop power supplying to load when changeover process of power supply is carried out. The switch is applicable for two circuits power supply and in the condition which requires high quality power supply.
Standard: IEC/EN 60947-3, 60947-6-1



2. Switch Disconnecter

N H 40 - □ / □ SZ □

Blank: common type
Main power supply —— standby power supply, automatic change and automatic recovery;
I : mains supply-mains supply, mutual standby, phase loss protection;
II : mains supply-mains supply, automatic change and automatic recovery, phase loss protection, overvoltage and undervoltage protection;
III : mains supply-oil engine, automatic change and automatic recovery, phase loss protection, overvoltage and undervoltage protection;

Dual-power supply automatic transfer

"3" represents three poles
"4" represents four poles

Rated operational current

Design sequence No.

Isolating switch

Company code

3. Povrameter

Conventional thermal current (A)	16	32	40	63	80	100	125	160	200	250	315	400	630	1000	1250	1600
Rated current of fuse (A)	16	32	40	63	80	100	125	160	200	250	315	400	630	1000	1250	2×800
Rated insulation voltage (V)	800															
400V AC-33IB	16	32	40	63	80	100	125	160	200	250	315	400	630	1000	1250	1600
Rated current(V)																
Operation force (N)	30~50					40~60			65~100			75~120			200~300	

4. Control characteristics and product structure

4.1 Control characteristics:

There are two types of switch products, three-pole and four-pole (three poles + switchable neutral pole).

Four control types (common type, I, II, III).

- a. Common type: Main power supply-standby power supply, automatic change and automatic recovery.
- b. I : mains supply-mains supply, mutual standby, phase loss protection.
- c. II : mains supply-mains supply, automatic change and automatic recovery, overvoltage and undervoltage protection, phase loss protection.
- d. III : mains supply-oil generator, automatic change and automatic recovery, overvoltage and undervoltage detection.
The automatic change-over control mechanism uses a key switch for the selection of operation mode.
The position can be maintained by padlock.

Control characteristics of common type switch:

- a. This switch applies to the automatic change and automatic recovery of main power supply-standby power supply (including manual oil generator; Note: Manual oil generator does not have to be used with type III switches) systems. Power supply I precedes. When power supply I is normal, it is switched on; when power supply I fails and power supply II is normal, the switch changes to power supply II; when power supply I resumes, the switch automatically changes to power supply I.

Control characteristics of type I switch:

- a. This switch applies to the mutual standby of mains supply-mains supply systems. When the switch is in the "0" position, power supply I precedes. When power supply I fails and power supply II is normal, the switch changes to power supply II; when power supply II is on and power supply I resumes, the switch does not automatically change to power supply I, it will change to power supply I only when power supply II fails. The main power supply changes to the standby power supply (the delay continuously adjustable between 1~999s), the standby power supply changes to the main power supply (the delay continuously adjustable between 1~999s).
- b. Phase loss detection protection function.

Control characteristics of type II switch:

- a. This switch applies to the automatic change and automatic recovery of mains supply-mains supply systems. Power supply I precedes. When power supply I is normal, it is switched on; when power supply I fails and power supply II is normal, the switch changes to power supply II; when power supply I resumes, the switch automatically changes to power supply I. The main power supply changes to the standby power supply (the delay continuously adjustable between 1~999s), the standby power supply changes to the main power supply (the delay continuously adjustable between 1~999s).
- b. Three-phase overvoltage, undervoltage and phase loss detection protection functions.

Control characteristics of type III switch:

- a. This switch applies to the mutual standby or automatic change and automatic recovery of mains supply-oil generator (automatic oil generator with signals) systems. Power supply I (the mains supply) precedes. When power supply I fails, the switch gives a signal to start the oil generator. The oil generator has warm-up delay (continuously adjustable between 0~180s) function. After the oil generator has started, the switch changes to power supply II (the oil generator). When power supply I resumes, the switch automatically changes to power supply I, the oil generator automatically stops after a cooling delay (continuously adjustable between 0~180s).
- b. Three-phase overvoltage and undervoltage protection functions for mains supply and oil generator.

Type I, type II and type III switches have:

- 1) Automatic, remote and manual control functions
- 2) A 0.5s delay of the detection signal, to prevent misoperation.
- 3) A remote control "0" position in automatic state.
- 4) A key switch for the selection of operation mode.

4.2 Product structure

16A-100A/4(Common type)

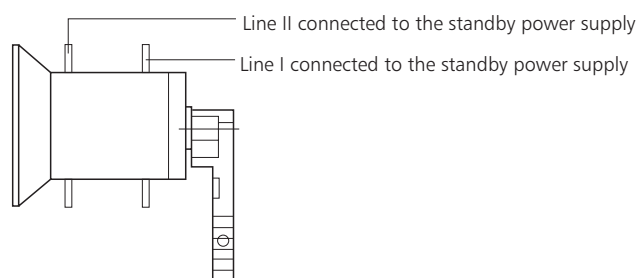
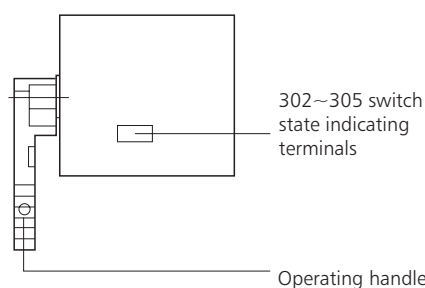
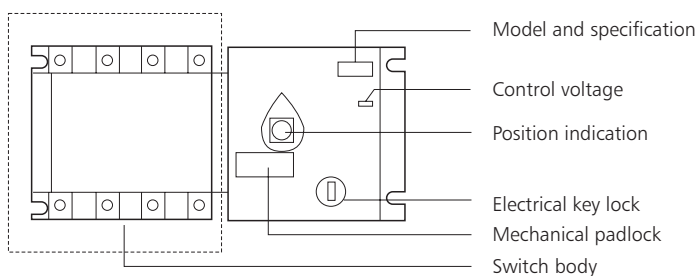

100A/3 common type; 100A/3, 4 type I, type II, type III; 125A-3200A/3, 4 common type, type I, type II, type III

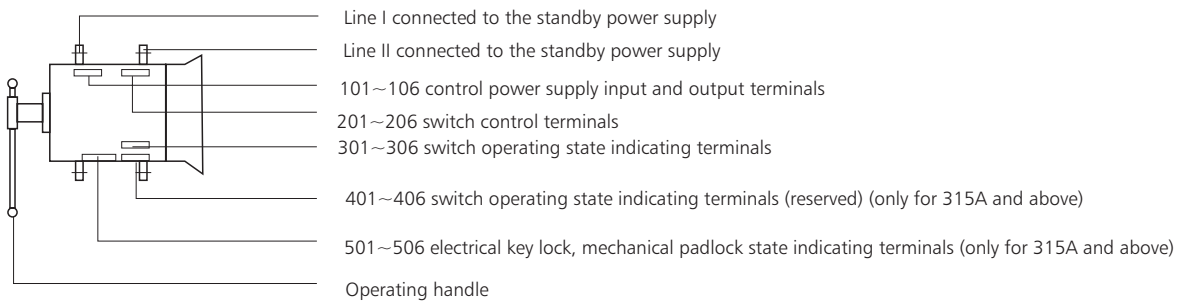
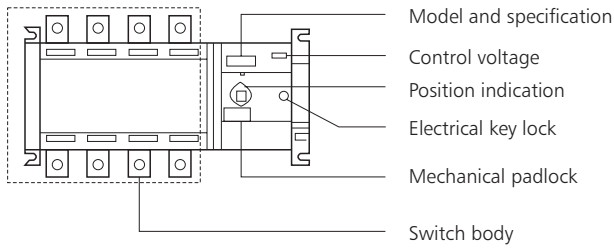

- a. Electrical key lock: It controls the power supply of the internal control circuit of the switch. When the electrical lock is in the "Automatic" position, the switch can be operated automatically or remotely. When the electrical lock is in the "Manual" position, the switch can only be operated manually;
- b. Operating handle: When operating the switch with the operating handle, the electrical lock must be in the "Manual" position;
- c. Mechanical padlock: Before maintenance, put the switch to the 0 position with the operating handle, pull up the padlock structure and lock the padlock. (Pulling up the mechanical padlock switches off the internal control power supply of the switch so that it cannot be operated electrically or manually);
- d. Position indication: It indicates the operating position (I; 0; II) of the switch;
- e. Control voltage: The control voltage class of the switch is 220VAC;
- f. Switch body: The front part is line I, which is connected to the "Normal power supply"; the rear part is line II, which is connected to the "Standby power supply".

4.3 Connection terminal of control circuit

Common type

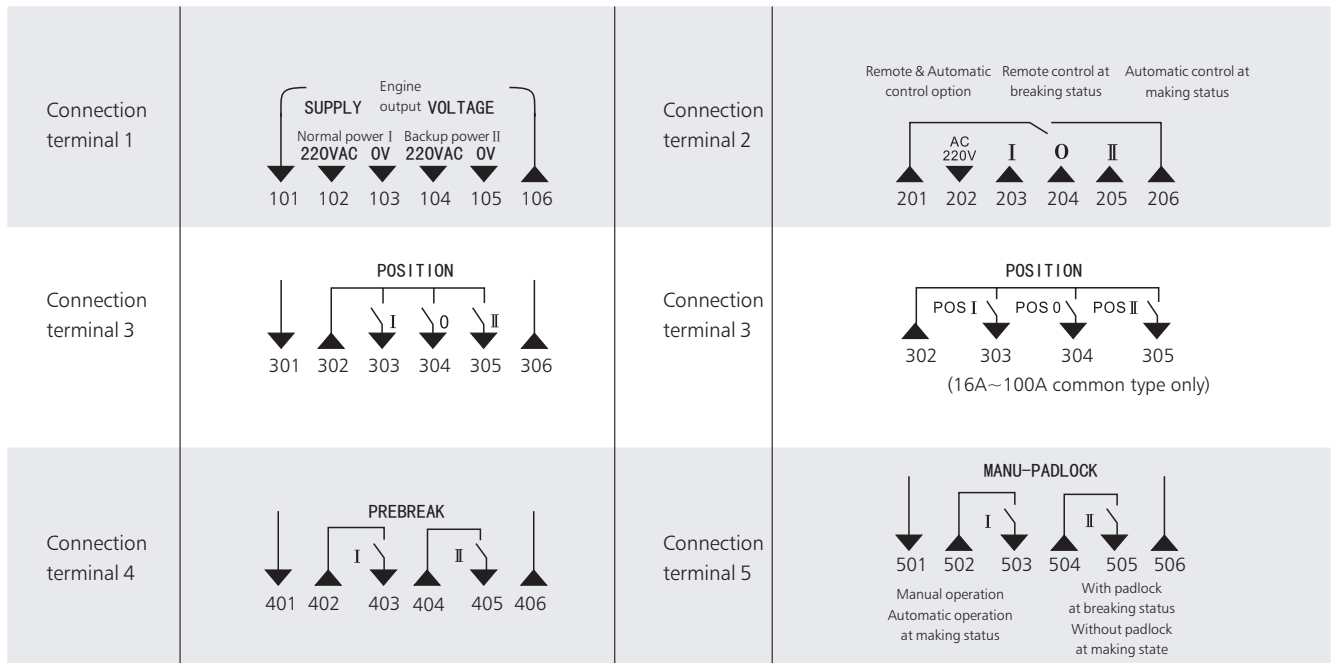

Type I and type II

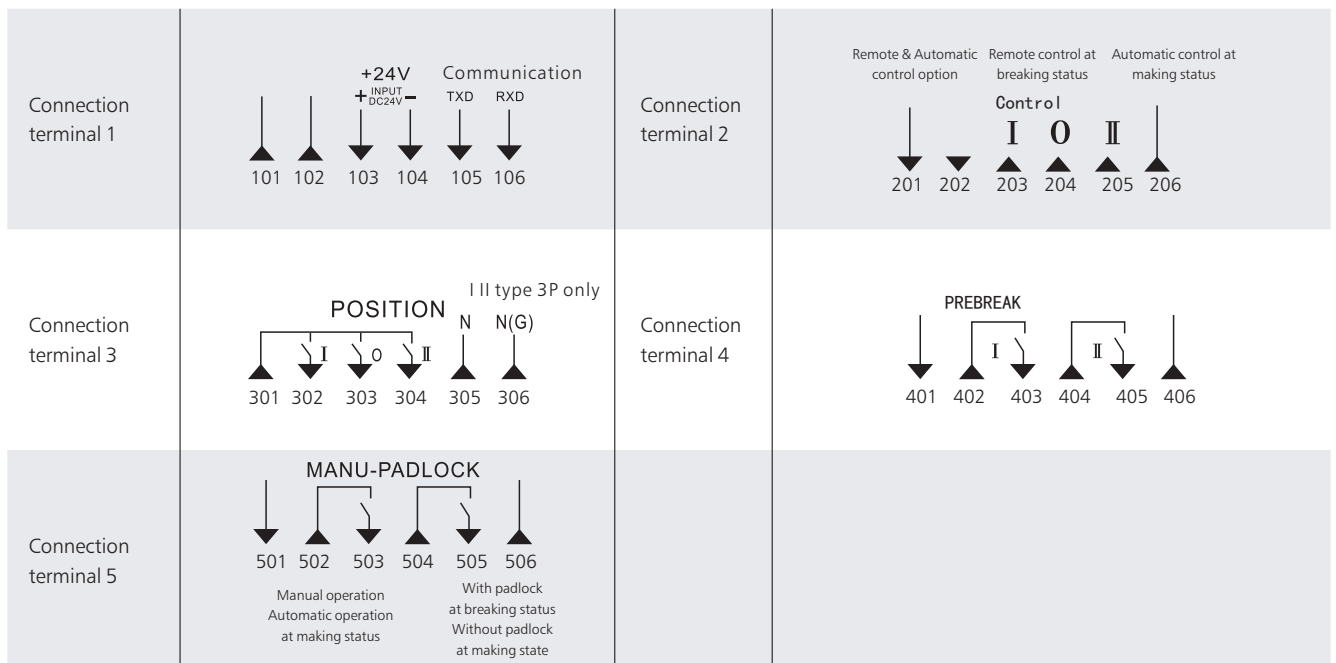

Type III

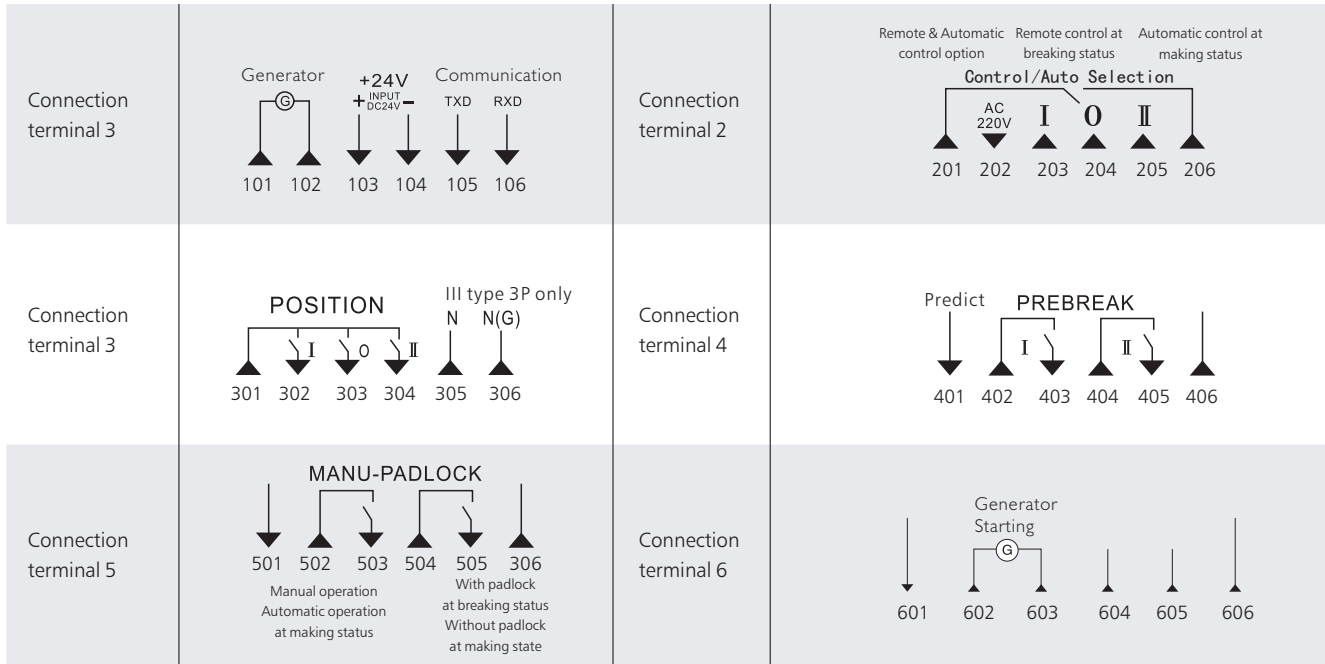

Terminal 1, main options

- 101, 106-AC220V output terminals of engine (only for common type)
- 102, 103-Power control terminal of circuit I (only for common type)
- 104, 105-Power control terminal of circuit II (only for common type)
- 101, 102-Generator starting signal input (for type III)
- 103, 104-Firefighting +24V input, enforce "0", both switches breaks (for type I, II, III)
- 105, 106-Communication Interface (Reserved)

Terminal 2, remote control

- 201, 206-Terminal of remote controlling, automatic controlling functions, Remote control at breaking status and automatic control at making status.
- 202, 203-Making switch I.
- 202, 204-At "0" position, both switches breaks (for type I, II, III) (include preferring position "0")
- 202, 205-Making switch II.

Terminal 3, position indication and zero-line terminal

- 301, 302-Switch I position
- 301, 303-At "0" position, all swithes breaks
- 301, 304-Switch II position, (301~304 for I II III, 4 poles switch)
- 302, 303-Switch I position
- 302, 304-"0" position
- 302, 305-Switch II position (302~305 for common type)
- 305-Type I, II, switch I controls zero-line "N1"; type III switch I controls zero-line "N" (only for 3 poles)

Terminal 4, pre-breaking auxiliary contact

- 306-Type I, II, switch II controls zero-line "N2"; type III, switch II controls zero-line "N(G)"
- 402, 403, Pre-breaking position of indication switch I .
- 404, 405, Pre-breaking position of indication switch II .

Terminal 5 Manual

- and automatic operation mode and whether locking the switch
 - 502, 503, Automatic and manual control indication
 - 504, 505, Indcation of whether locking the switch
- Terminal 6 Start-up terminals for diesel generator

Terminal 6, control generator

- 602, 603, Generator starting terminal. (Only for type III). Two zero-lines of 3-poles switch should be connected to the terminal 305, 306 (1~1.5mm² copper), at right side switch. (for Type III ≥800A)

5 Connection diagram

5.1 16A~100A 4 poles main switch wiring diagram

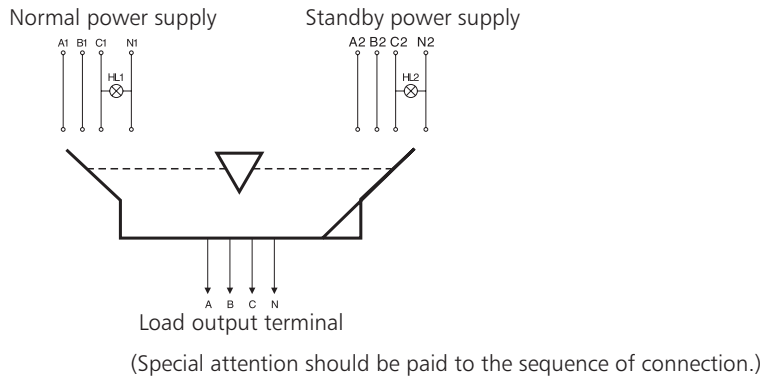

Secondary connection diagram

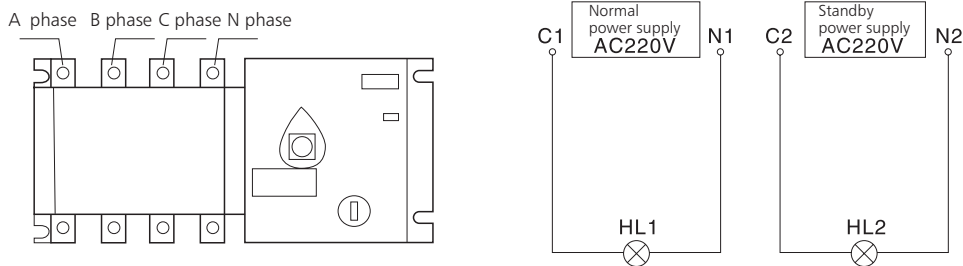

Connected to load output terminal

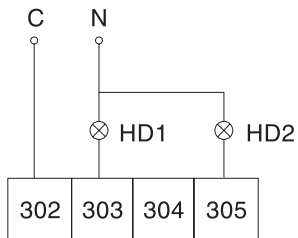

HL1 and HL2 are respectively the resumption indicators of the normal and standby power supplies;
HD1 and Hd2 are respectively the service indicators of the normal and standby power supplies;
302~305 are switch terminals.

5.2 125A~3200A main switch wiring diagram

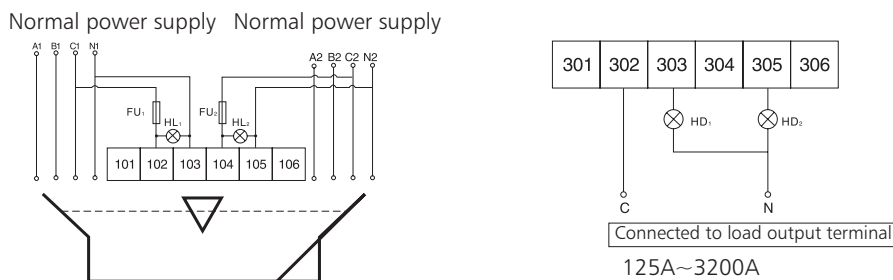

Note: Secondary connection of terminal 1 is required (for 16A~100A with forced reset, the connection mode is the same as above).

5.3 125A~3200A Secondary wiring diagram (3P, 4P)

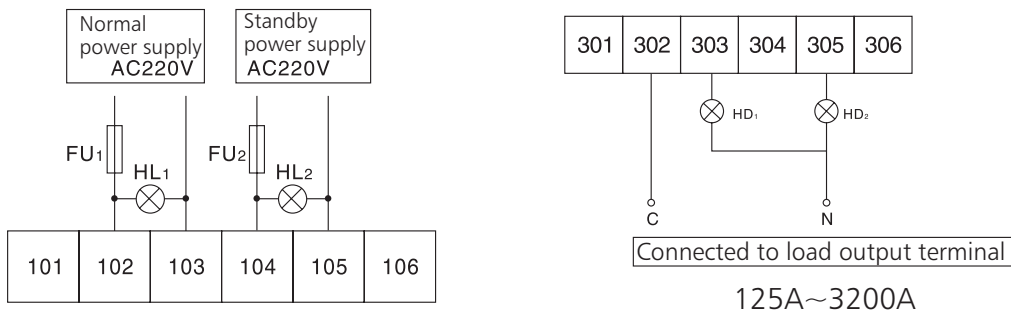

HL1 and HL2 are respectively the resumption indicators of the normal and standby power supplies;
 HD1 and Hd2 are respectively the service indicators of the normal and standby power supplies;
 FU1 and FU2 are 5A fuses;
 101~106, 201~206, 301~306 are switch terminals.

5.4 Depending on the operating mode, the following connection modes can be used for terminal 2:

a. Fully automatic connection mode

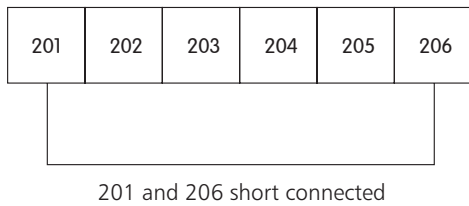

Note: Secondary connection of terminal 1 is required.

b. Remote reset (the two power supplies are disconnected) connection mode

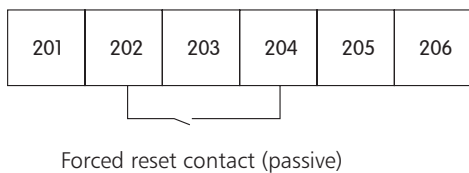

Only for 16A~3200A (Type I II III)

c. Remote connection mode (Note: SB1 and SB2 are external push-button switches)

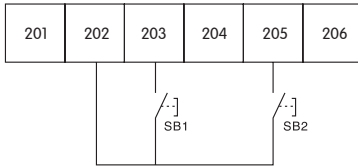

Note: When switch SA is in the automatic position, ① and ② are connected.
When switch SA is in the manual position, ④ and ③ are connected.

d. Fully automatic + manual (remote) connection mode (Note: SB1 and SB2 are external push-button switches)

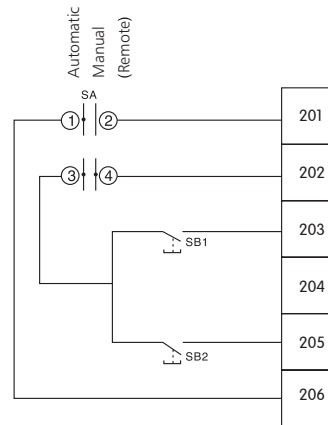

5.5 Connection diagram

NH40-16~100

16~100A 3P connection chart

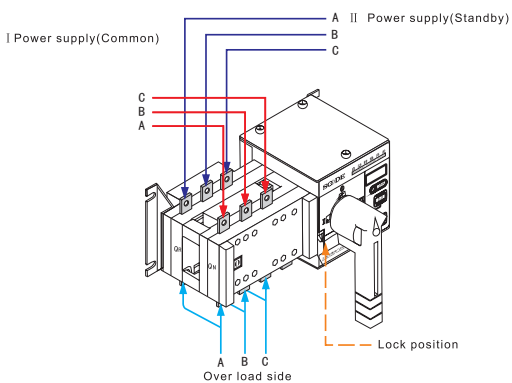

16~100A 3P connection chart

16~100A 4P connection chart

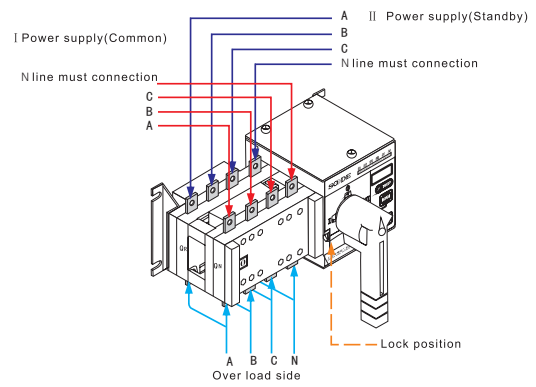

16~100A 4P connection chart

Correct mounting of the switch:

- Copper busbars I and II are respectively connected to phases A, B, C, N of the normal (front) and standby (rear) power supplies from left to right.
- The control power supplies are obtained respectively from phases C and N of the normal and standby power supplies.
- AC220V control power supplies I and II are respectively connected to terminals 102~103 and 104~105, among which 102 and 104 are respectively the live wires of the normal and standby power supplies.
- Terminals 1.1 and 106 are only used as the control power supplies of the signal lamps. Note: They should not be connected to any other lines.
- When upper (lower) incoming line is used, phases A, B, C, N of the lower (upper) lines I and II are respectively connected with copper busbars or conductors as the output.

6. Mounting dimension of NH40SZ automatic changeover switch disconnecter

≤ 1600A

Electric wire controlling connecting area

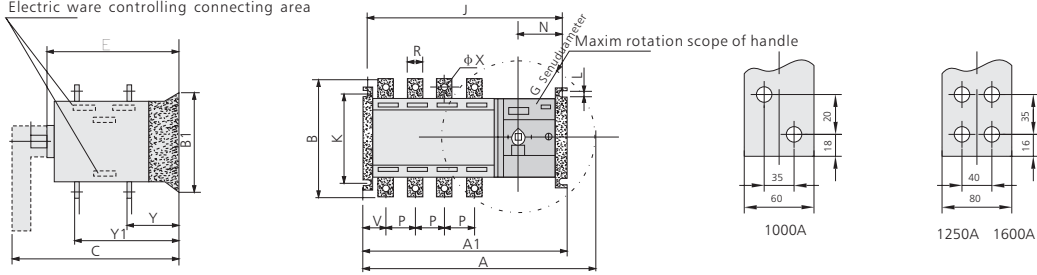

≥ 2000A

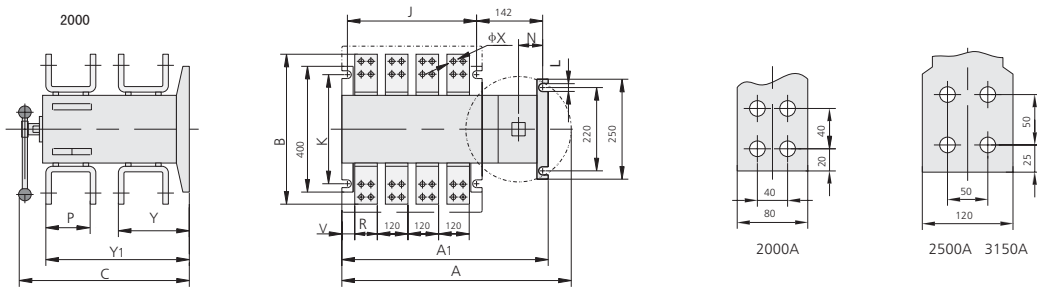

Specification	NH40SZ Mounting dimensions														
lth/Poles	A	A1	B	C	E	J	K	L	N	P	R	V	φX	Y	Y1
16A/3、4	380	245	106	170	133	234	84	7	75	30	14	10.5	6	36	86
32A/3、4	380	245	106	170	133	234	84	7	75	30	14	10.5	6	36	86
40A/3、4	380	245	106	170	133	234	84	7	75	30	14	10.5	6	36	86
63A/3、4	380	245	106	170	133	234	84	7	75	30	14	10.5	6	36	86
80A/3、4	380	245	106	170	133	234	84	7	75	30	14	10.5	6	36	86
100A/3、4	380	245	106	170	133	234	84	7	75	30	14	10.5	6	36	86
125A/3	405	270	135	240	208	255	95/110	7	87	36	20	20	9	58	135
160A/3	405	270	135	240	208	255	95/110	7	87	36	20	20	9	58	135
125A/4	435	300	135	240	208	285	95/110	7	87	36	20	20	9	58	135
160A/4	435	300	135	240	208	285	95/110	7	87	36	20	20	9	58	135
200A/3	416	310	170	240	208	293	95/110	7	87	50	25	27	11	60	140
250A/3	416	310	170	240	208	293	95/110	7	87	50	25	27	11	60	140
200A/4	466	360	170	240	208	343	95/110	7	87	50	25	27	11	60	140
250A/4	466	360	170	240	208	343	95/110	7	87	50	25	27	11	60	140
315A/3	465	375	240	315	270	355	180	11	95	65	32	37.5	11	84	195
400A/3	465	375	240	315	270	355	180	11	95	65	32	37.5	11	84	195
630A/3	465	375	260	315	270	355	180	11	95	65	40	37.5	13	84	195
315A/4	525	435	240	315	270	415	180	11	95	65	32	37.5	11	84	195
400A/4	525	435	240	315	270	415	180	11	95	65	32	37.5	11	84	195
630A/4	525	435	260	315	270	415	180	11	95	65	40	37.5	13	84	195
1000A/3	887	515	310	368	320	490	220	13	88	120	60	198	13	108	252
1250A/3	887	515	360	368	320	490	220	13	88	120	70	198	13	108	252
1600A/3	887	515	360	368	320	490	220	13	88	120	80	198	13	108	252
1000A/4	1007	635	310	368	320	610	220	13	88	120	60	198	13	108	252
1250A/4	1007	635	360	368	320	610	220	13	88	120	70	198	13	108	252
1600A/4	1007	635	360	368	320	610	220	13	88	120	80	198	13	108	252
2000A/4	1007	633	455	562	495	467	220	11	85	147	80	33	13	226	457
2500A/4	1007	633	455	562	495	467	220	11	85	152	120	33	13	230	462
3200A/4	1007	633	505	562	495	467	220	11	85	152	120	33	13	230	462